

DETAIL OF MOUNTING BLOCK

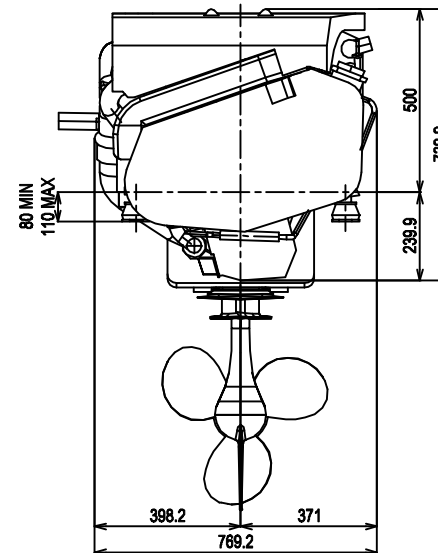
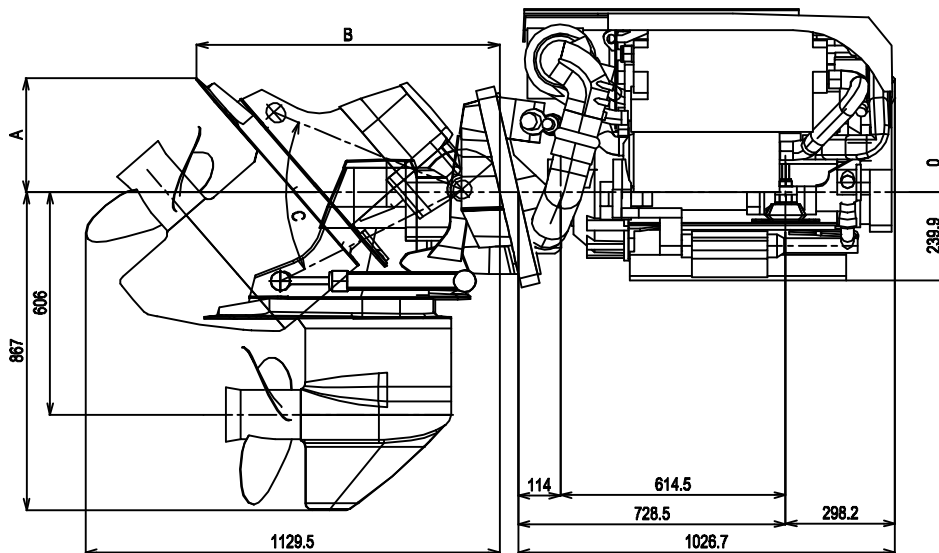
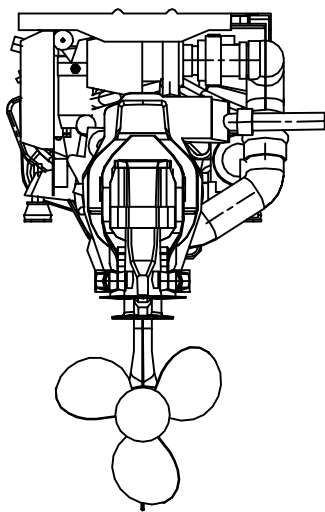
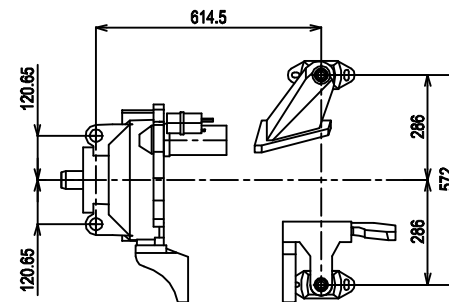
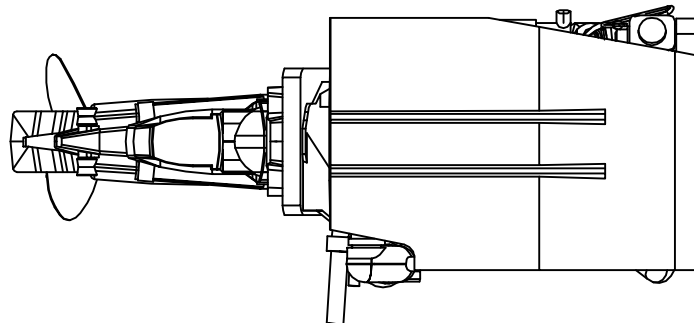
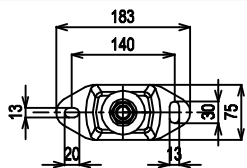

WITH TRIM-IN LIMIT INSERT IN REAR POSITION	.62" TILT-UP LIMIT SPACERS	A	B	C (MAX)
	0	334 [13-3/16]	819 [32-1/4]	51°
	1	289 [11-3/8]	238 [9-3/8]	46°
	2	276 [10-7/8]	260 [10-1/4]	41.3°

WITH TRIM-IN LIMIT INSERT IN FORWARD POSITION	.62" TILT-UP LIMIT SPACERS	A	B	C (MAX)
	0	289 [11-3/8]	238 [9-3/8]	46°
	1	276 [10-7/8]	260 [10-1/4]	41.3°
	2	263 [10-3/8]	281 [11-1/16]	36.8°

NOTE: ALL DIMENSIONS ARE IN MM

Scale **1/10** **YANMAR MARINE INTERNATIONAL**
November 2006

6BY220-260xBRAVO2