

DETAIL OF MOUNTING BLOCK

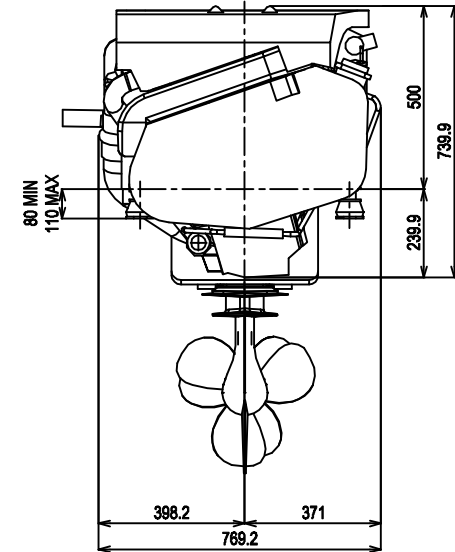
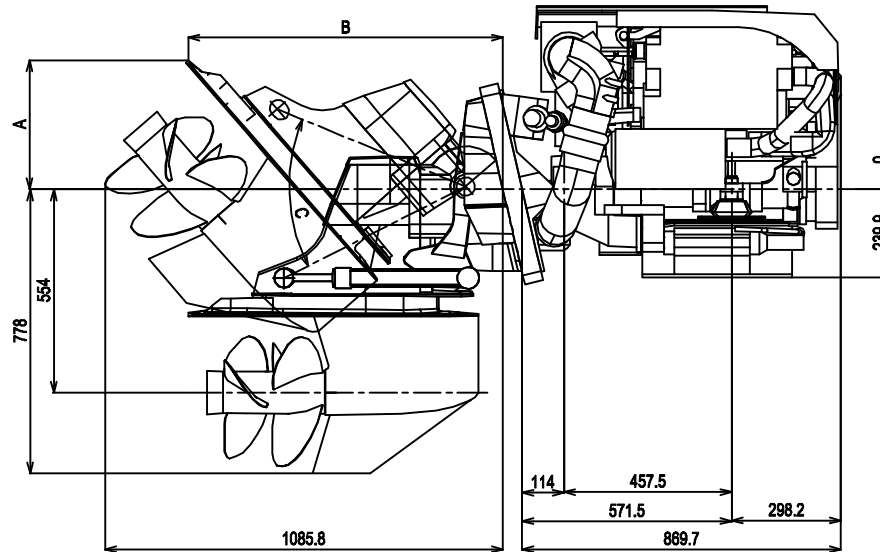
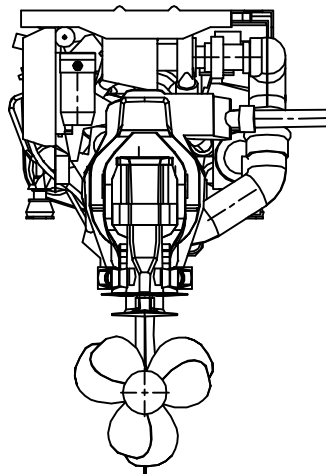
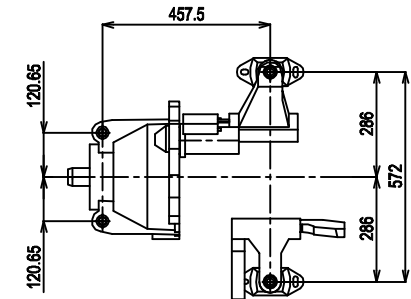
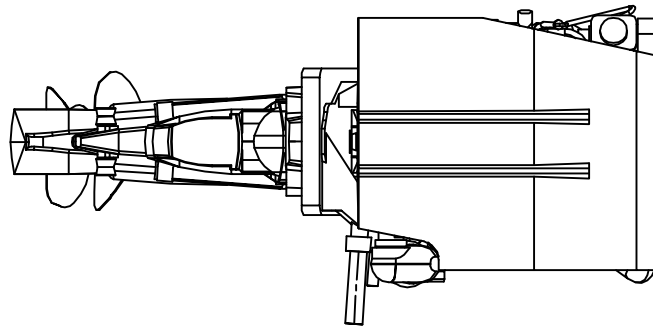
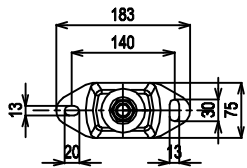

WITH TRIM-IN LIMIT INSERT IN REAR POSITION	.62" TILT-UP LIMIT SPACERS	A	B	C (MAX)
	0	375 [14-3/4]	851 [33-1/2]	51°
	1	309 [12-1/8]	880 [34-5/8]	46°
	2	278 [10-15/16]	260 [10-1/4]	41.3°

WITH TRIM-IN LIMIT INSERT IN FORWARD POSITION	.62" TILT-UP LIMIT SPACERS	A	B	C (MAX)
	0	308 [12-1/8]	880 [34-11/16]	46°
	1	277 [10-15/16]	260 [10-1/4]	41.3°
	2	263 [10-3/8]	281 [11-1/16]	36.8°

NOTE: ALL DIMENSIONS ARE IN MM